

Analog Devices Welcomes Hittite Microwave Corporation

NO CONTENT ON THE ATTACHED DOCUMENT HAS CHANGED



THIS PAGE INTENTIONALLY LEFT BLANK

WIDEBAND POWER AMPLIFIER BENCHTOP MODULE, 0.01 - 15 GHz



Typical Applications

The HMC-C037 Wideband PA is ideal for:

- Lab Instrumentation
- Test Equipment

Features

- Gain: 12 dB
- P1dB Output Power: +28 dBm
- Eliminates Band Switching
- Excellent Gain Flatness
- Regulated Supply and Bias Sequencing
- Hermetically Sealed Module
- Field Replaceable SMA connectors
- 0 to +85°C Operating Temperature

Functional Diagram

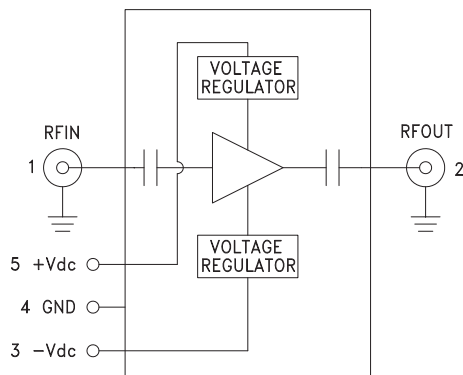

General Description

The HMC-C037 is a GaAs MMIC PHEMT Power Amplifier in a benchtop, hermetic module with replaceable SMA connectors and integral heatsink which operates between 0.01 GHz and 15 GHz. The amplifier provides 12 dB of gain, up to +37 dBm output IP3 and up to +28 dBm of output power at 1 dB gain compression. Gain flatness is excellent at ± 0.3 dB from 2 - 12 GHz making the HMC-C037 ideal for general purpose lab instrumentation applications. The wideband amplifier I/Os are internally matched to 50 Ohms and are DC blocked. Integrated voltage regulators allow for flexible biasing of both the negative and positive supply pins, while internal bias sequencing circuitry assures robust operation.

Electrical Specifications, $T_A = +25^\circ\text{C}$, +Vdc = +11V to +16V, -Vdc = -3V to -12V

Parameter	Min.	Typ.	Max.	Min.	Typ.	Max.	Min.	Typ.	Max.	Units
Frequency Range	0.5 - 6.0			6.0 - 12.0			12.0 - 15.0			GHz
Gain	9.5	12.5		9	12		8	11		dB
Gain Flatness		± 0.3			± 0.3			± 0.6		dB
Gain Variation Over Temperature		0.02			0.02			0.02		dB/°C
Noise Figure		4.5			4.0			7.0		dB
Input Return Loss		22			11			4		dB
Output Return Loss		13			12			10		dB
Output Power for 1 dB Compression (P1dB)	25	28		23	26		23	26		dBm
Saturated Output Power (Psat)		29			27			28		dBm
Output Third Order Intercept (IP3)		36			37			32		dBm
Positive Supply Current (+IDC)		360			360			360		mA
Negative Supply Current (-IDC)		-5.5			-5.5			-5.5		mA

**WIDEBAND POWER AMPLIFIER
BENCHTOP MODULE, 0.01 - 15 GHz**

Gain & Return Loss

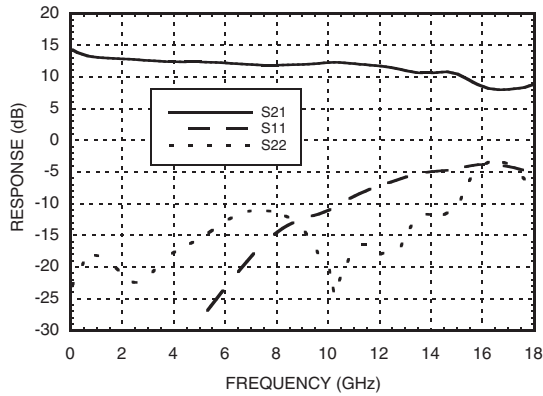

Gain vs. Temperature

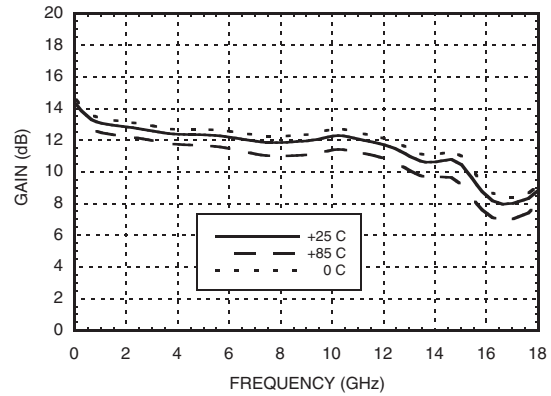

Input Return Loss vs. Temperature

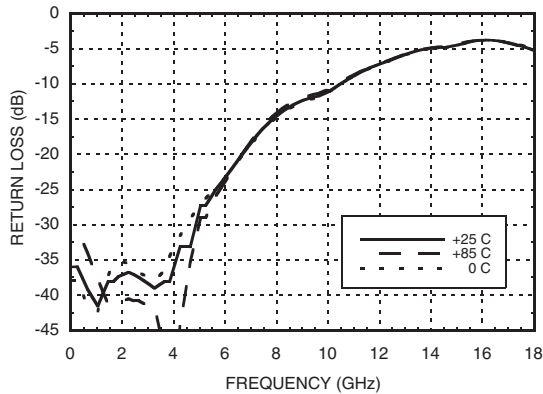

Output Return Loss vs. Temperature

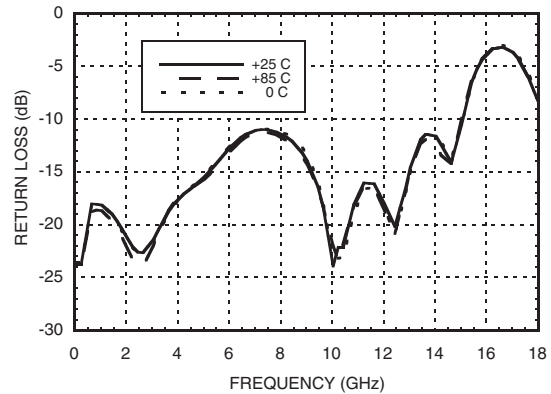

Reverse Isolation vs. Temperature

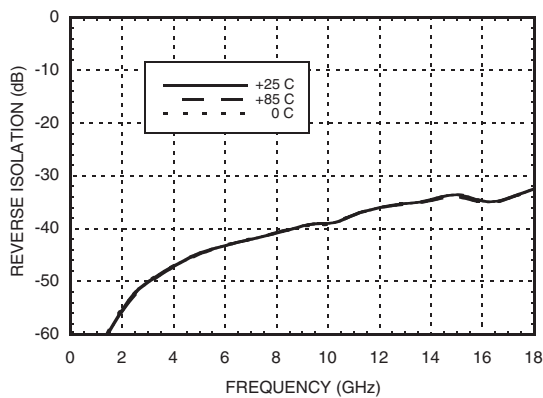

Noise Figure vs. Temperature

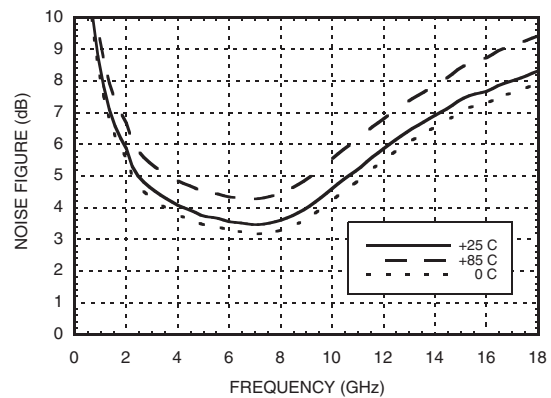

WIDEBAND POWER AMPLIFIER BENCHTOP MODULE, 0.01 - 15 GHz

P1dB vs. Temperature

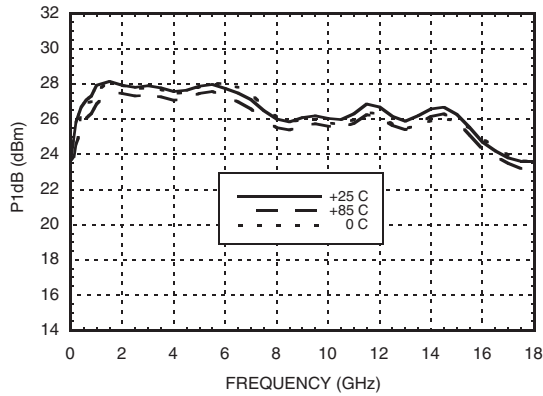

Psat vs. Temperature

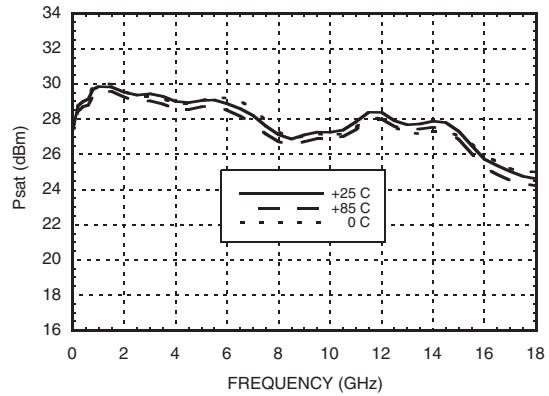

Output IP3 vs. Temperature

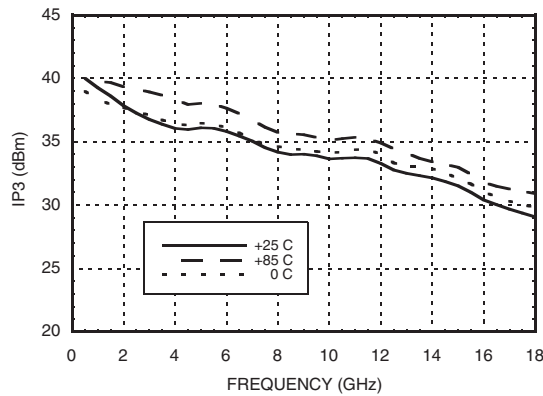

Group Delay

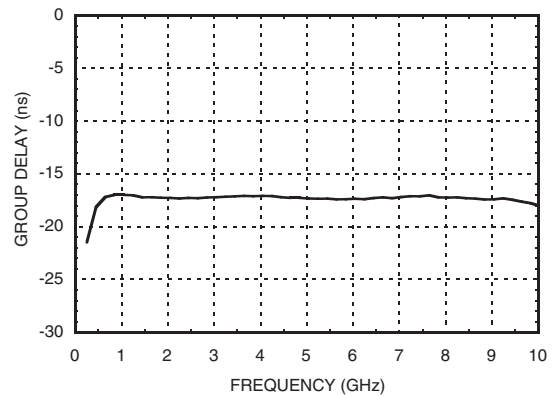

Deviation from Linear Phase

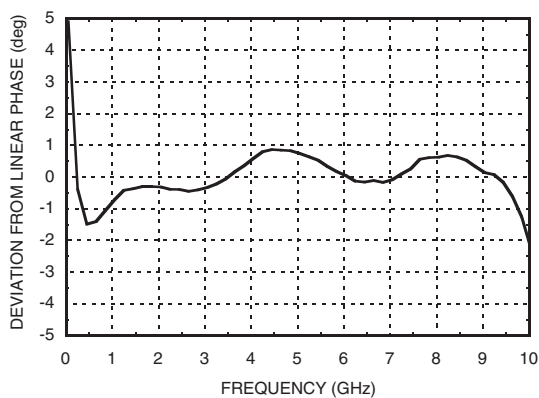

Low Frequency Gain & Return Loss

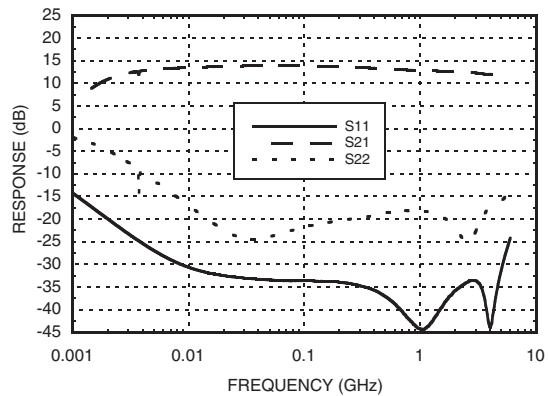

**WIDEBAND POWER AMPLIFIER
BENCHTOP MODULE, 0.01 - 15 GHz**



Absolute Maximum Ratings

Positive Bias Supply Voltage (+Vdc)	+17V Max
Negative Bias Supply (-Vdc)	-16V Min.
Maximum RF Input Power	
Peak	24 dBm
CW @ 0.01 - 6 GHz	22 dBm
CW @ 6 - 12 GHz	21 dBm
CW @ 12 - 20 GHz	18 dBm
Storage Temperature	-65 to +150 °C
Operating Temperature	0 to +85 °C

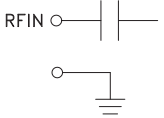
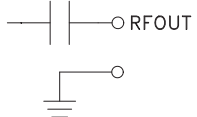
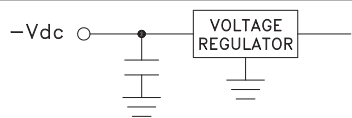

**ELECTROSTATIC SENSITIVE DEVICE
OBSERVE HANDLING PRECAUTIONS**

Pin Descriptions

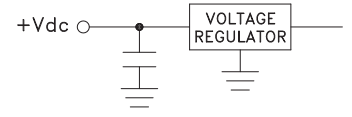
Pin Number	Function	Description	Interface Schematic
1	RFIN & RF Ground	RF input connector, SMA female, field replaceable. This pin is AC coupled and matched to 50 Ohms.	
2	RFOUT & RF Ground	RF output connector, SMA female. This pin is AC coupled and matched to 50 Ohms.	
3	-Vdc	Negative power supply voltage for the amplifier	
4	GND	Power supply ground.	
5	+Vdc	Positive power supply voltage for the amplifier.	

**WIDEBAND POWER AMPLIFIER
BENCHTOP MODULE, 0.01 - 15 GHz**

Outline Drawing

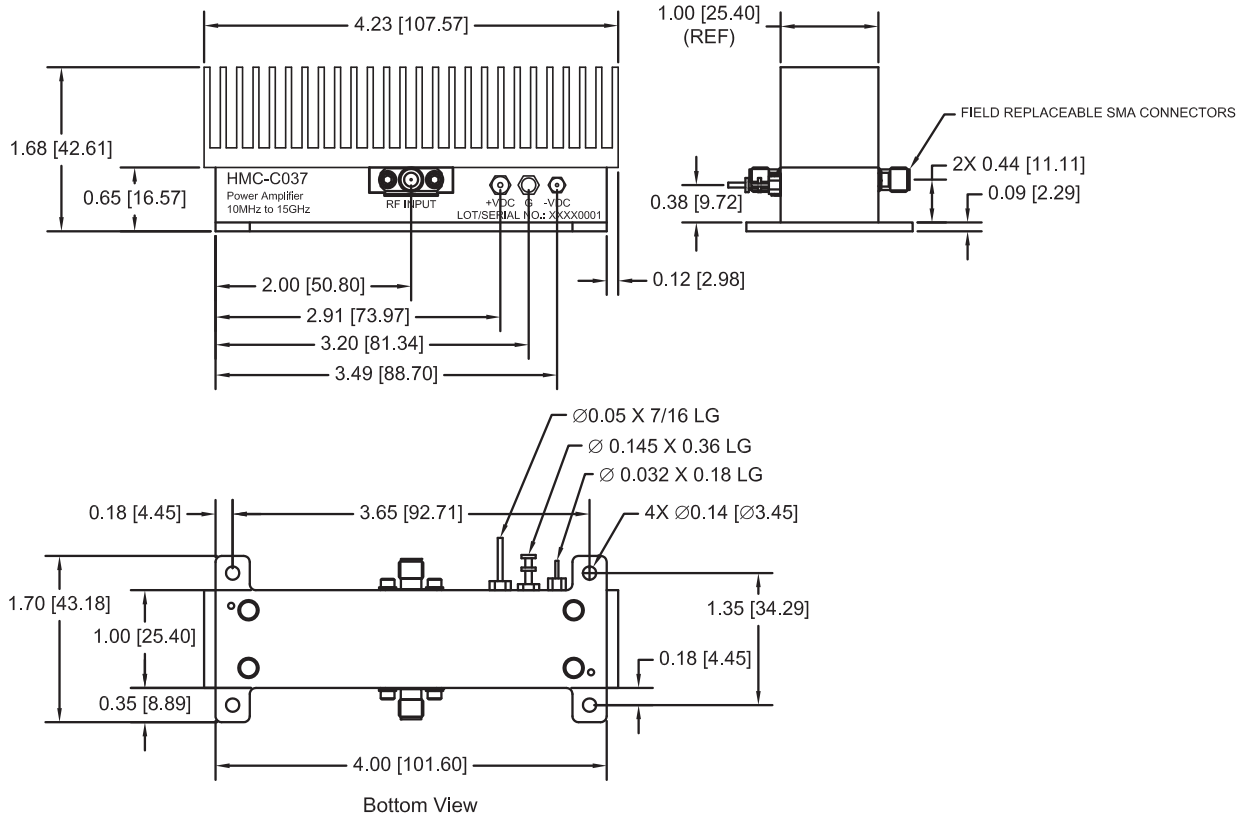

Package Information

Package Type	C-12
Package Weight ^[1]	164.2 gms ^[2]
Spacer Weight	N/A

[1] Includes the connectors

[2] ±16 gms Tolerance

NOTES:

1. PACKAGE: ALUMINUM.
2. FINISH: (HEATSINK) ANODIZED, (HOUSING AND BASEPLATE): IRIDITE CHEMICAL FILM PER MIL-C-5541 CLASS C.
3. ALL DIMENSIONS ARE IN INCHES [MILLIMETERS].
4. TOLERANCES: ±0.010 [0.25] UNLESS OTHERWISE SPECIFIED

**WIDEBAND POWER AMPLIFIER
BENCHTOP MODULE, 0.01 - 15 GHz**

Notes: